

Research

Motifs in bipartite ecological networks: uncovering indirect interactions

Benno I. Simmons, Alyssa R. Cirtwill, Nick J. Baker, Hannah S. Wauchope, Lynn V. Dicks, Daniel B. Stouffer and William J. Sutherland

B. I. Simmons (http://orcid.org/0000-0002-2751-9430) (benno.simmons@gmail.com), H. S. Wauchope and W. J. Sutherland, Dept of Zoology, Univ. of Cambridge, The David Attenborough Building, Pembroke Street, Cambridge, CB2 3QZ, UK. L. V. Dicks, School of Biological Sciences, Univ. of East Anglia, UK. – A. R. Cirtwill (http://orcid.org/0000-0002-1772-3868), Dept of Physics, Chemistry and Biology (IFM), Linköping Univ., Linköping, Sweden. – N. J. Baker and D. B. Stouffer, Centre for Integrative Ecology, School of Biological Sciences, Univ. of Canterbury, Christchurch, New Zealand.

Oikos

00: 1–17, 2018

doi: 10.1111/oik.05670

Subject Editor: Ignasi Bartomeus

Editor-in-Chief: Dries Bonte

Accepted 25 August 2018

Indirect interactions play an essential role in governing population, community and coevolutionary dynamics across a diverse range of ecological communities. Such communities are widely represented as bipartite networks: graphs depicting interactions between two groups of species, such as plants and pollinators or hosts and parasites. For over thirty years, studies have used indices, such as connectance and species degree, to characterise the structure of these networks and the roles of their constituent species. However, compressing a complex network into a single metric necessarily discards large amounts of information about indirect interactions. Given the large literature demonstrating the importance and ubiquity of indirect effects, many studies of network structure are likely missing a substantial piece of the ecological puzzle. Here we use the emerging concept of bipartite motifs to outline a new framework for bipartite networks that incorporates indirect interactions. While this framework is a significant departure from the current way of thinking about bipartite ecological networks, we show that this shift is supported by analyses of simulated and empirical data. We use simulations to show how consideration of indirect interactions can highlight differences missed by the current index paradigm that may be ecologically important. We extend this finding to empirical plant–pollinator communities, showing how two bee species, with similar direct interactions, differ in how specialised their competitors are. These examples underscore the need to not rely solely on network- and species-level indices for characterising the structure of bipartite ecological networks.

Keywords: indirect interactions, ecological networks, mutualistic networks, food webs, parasitism, seed dispersal, pollination, herbivory, motifs

Introduction

Ecological communities are widely represented as bipartite networks that depict interactions between two groups of species, such as plants and pollinators. These networks are used to answer a diverse range of questions about community structure, such as whether antagonistic and mutualistic communities have different architectures

(Fontaine et al. 2011, Morris et al. 2014); how plant–frugivore communities at forest edges differ from those in forest interiors (Menke et al. 2012); whether fluctuations in species and interactions over time alter network structure (Petanidou et al. 2008); and whether individual pollinators vary in their use of floral patches (Dupont et al. 2014).

For over thirty years, the framework for characterising the structure of bipartite networks has remained unchanged: indices, such as nestedness and species degree, are used to describe either whole-network topology or the roles of individual species with a single summary statistic. However, while these network- and species-level indices have greatly improved our understanding of community structure, they also suffer from a substantial, but largely ignored, ecological limitation: reducing a complex network to a handful of one-dimensional metrics necessarily involves a loss of information. This is because network and species-level indices are insensitive to changes in pairwise species interactions: different network configurations can have identical index values (Olito and Fox 2015). Often this means discarding important detail about indirect interactions. For example, let there be two communities: in the first community, plant i is pollinated by one species, j ; in the second community, i is still only pollinated by j , but j also pollinates plants k , l and m . We cannot distinguish the two situations by examining, for example, the degree of i because degree discards all information on indirect interactions: we know that i has a direct interaction with j , but we do not know whether j is an obligate specialist on i or a generalist visiting several other plants.

The loss of ecological detail resulting from the use of network and species-level indices is concerning as it puts many studies describing network structure directly at odds with a large literature that has repeatedly documented important and widespread indirect effects in nature (Wootton 2002). For example, in mutualistic networks, dynamical models (which use the whole network as the skeleton of dynamics and therefore incorporate indirect interactions) have shown that indirect effects are a major process governing coevolution (Guimarães et al. 2017), while in host–parasitoid communities, apparent competition and even apparent mutualism can occur when herbivorous insects influence each other through shared natural enemies (Morris et al. 2004, Frank van Veen et al. 2006, Tack et al. 2011). Similarly, indirect effects between co-flowering plant species in pollinator communities can range from facilitation, where the presence of one plant increases the frequency of pollinator visits to another, to competition, where one plant attracts pollinators away from another (Mitchell et al. 2009, Morales and Traveset 2009, Carneiro et al. 2014). Indirect interactions are therefore a fundamental component of ecosystems, driving ecological and evolutionary processes to an equal, or greater, extent than direct interactions (Vandermeer et al. 1985, Strauss 1991, Bailey and Whitham 2007, Martínez et al. 2014, Guimarães et al. 2017). Widespread, uncritical use of network and species-level indices as the sole method for

characterising network structure risks missing all or part of this component.

Here we advocate a new way of thinking about bipartite networks that complements existing index-based approaches by incorporating more explicit detail on realised direct interactions and thus potential indirect interactions. We argue for conceptualising networks as a collection of constituent parts or ‘building blocks’ using the emerging concept of bipartite motifs (subgraphs representing patterns of interactions between a small number of species). We outline the theory, applications and future directions of this framework. We show that a motif conceptualisation of networks is well supported by simulated and empirical data, using three analyses to demonstrate the importance of the local-scale topological detail captured by motifs. First, we use three six-species networks to show that indirect interactions are necessary to accurately describe a species’ role in even a small community. Through simulation, we then generalise this finding to a large ensemble of networks with diverse sizes and structures to establish and quantify how communities and species with similar overall properties can exhibit remarkable dissimilarity in their indirect interaction structures. Finally, we demonstrate these results in an empirical context, highlighting how indirect interactions can result in ecologically important differences between two pollinator species with similar direct interactions. We also assess the robustness of the framework to sampling effort and propose several hypotheses about how our understanding of ecological communities might change if indirect interactions were incorporated. While our focus here is on bipartite mutualistic networks, such as those representing plant–pollinator interactions, we note that the ideas presented here are also applicable to non-mutualistic bipartite networks, such as plant–pest, host–parasitoid or plant–herbivore networks, and so we also provide some applications of our framework to these non-mutualistic systems. Importantly, we do not advocate removing network and species-level indices from the network ecologists ‘toolbox’. Instead we hope to raise awareness of network and species-level indices’ limitations and promote bipartite motifs as a complementary framework for characterising network structure. We anticipate a future where index- and motif-based approaches coexist in both empirical and theoretical studies of ecological networks.

Indirect interactions and the index paradigm

We define indirect interactions as the impact of one species on another, mediated by one or more intermediary species (Wootton 1994, 2002). There are two main types of indirect effects (Wootton 1994, 2002) (Supplementary material Appendix 3 Fig. A4). First, changes in the abundance of a donor species can influence the abundance of a recipient species by affecting the abundance of an intermediary species that interacts with both (Wootton 1994). This is known as an interaction chain (Supplementary material Appendix 3 Fig. A4). Chains can comprise multiple steps, with more than

one intermediary species: for example, in network I in Fig 1a, a change in the abundance of species *D* could indirectly affect the abundance of species *C*, through changes in the abundances of species *A* and *E*. Classic examples of interaction chains include apparent competition, exploitative competition, omnivory and tri-trophic chains (also known as trophic cascades). The second type of indirect interaction is where the interaction between two species is affected by a third species (Supplementary material Appendix 3 Fig. A4). This is known as an interaction modification. For example, a predator may refrain from feeding in a patch due to the presence of a defended plant species, therefore reducing consumption of another undefended plant species (Hay 1986, Pfister and Hay 1988, Wootton 1994). Here we focus on interaction chains, as these are represented by the topology of the network and are therefore captured explicitly by motifs. For example, among studies of unipartite (one type of node) food webs, where motif analyses are more common, motifs have been used to capture classic interaction chains like apparent competition, exploitative competition, omnivory and tri-trophic chains (Fig. 2a) (Camacho et al. 2007, Kondoh 2008, Bascompte and Stouffer 2009, Stouffer and Bascompte 2010).

To illustrate the importance of interaction chains, consider the example of species *B* in the three communities shown in Fig. 1a. Based only on its direct interactions, the role of *B* is identical in all three communities: *B* interacts with *E*. However, by considering the interactions of *B*'s partner *E*, *B*'s role in networks I and III can be distinguished from its role in network II: in networks I and III, *B* competes with *A* and *C* for the shared resource *E*, while in network II, *B* competes with only *A*. In other words, in networks I and III, *C* can indirectly influence *B* through a short interaction chain with only one intermediary species (*E*), while in network II, the interaction chain between *C* and *B* is longer, involving three intermediary species (*F*, *A* and *E*). Furthermore, by considering the interactions of *A* and *C* (*B*'s partners' partners), the roles of *B* in networks I and III can also be distinguished: in network I, *B*'s competitor *C* is a specialist on resource *E*, while in network III, *C* also visits *F*. Similarly, while *A* is a super-generalist in network I, visiting every resource in the

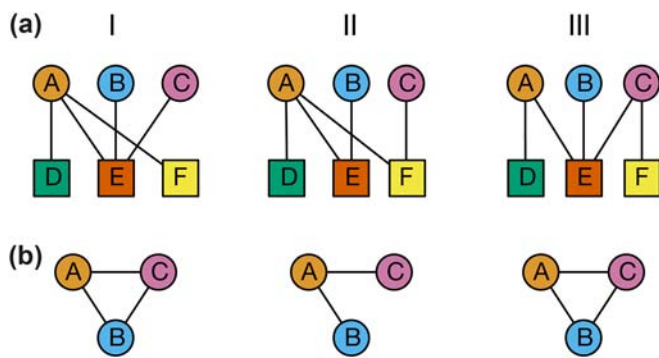

Figure 1. Three example networks (a) and the corresponding one-mode projections for species in the upper level (circle species) (b).

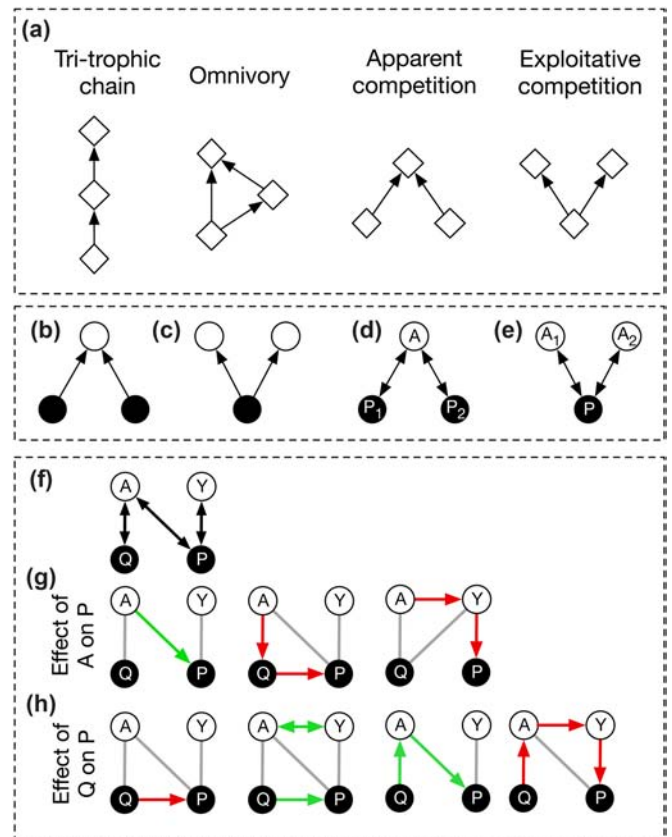

Figure 2. A selection of unipartite and bipartite motifs and their indirect effects. (a) Four classic unipartite motifs representing well-studied interaction chains. Motif 2 (b) and motif 3 (c) in an antagonistic network, with directed interactions from the lower to the higher trophic level (see Fig. 3 for motif IDs). Motif 2 (d) and motif 3 (e) in a mutualistic network, with bidirectional interactions representing the mutual benefit that species receive from each other. P_1 , P_2 and P represent plant species, while A , A_1 and A_2 represent animal species. (f) Motif 5 with mutualistic interactions as discussed in Vázquez et al (2015). (g) and (h) represent the direct and indirect effects of A on P (g) and Q on P (h). Arrows are coloured according to the net effect of A or P or Q on P , not according to the effect on any intermediate species. Paths resulting in a positive effect are shown in green, while paths resulting in a negative effect are shown in red. Adapted from Vázquez et al. (2015).

community, in network III it has a narrower diet breadth, visiting only *D* and *E*.

This simple example shows how indirect interactions are necessary to give a complete picture of a species' role, even in a small community: between the three networks, *B* differs both in the number of competitors it has and in how specialised these competitors are on the shared resource *E*. Such differences are likely to have important ecological consequences. To capture this detail, it was not sufficient to consider only *B*'s direct interactions, or even the interactions of *B*'s partner; rather we had to go 'deeper' and consider the interactions of *B*'s partners' partners to differentiate its role in all three networks.

However, it is difficult to capture these differences using traditional indices. Many indices that capture interaction

patterns at the level of individual species – such as degree, dependence (the strength of an interaction between species i and j as a proportion of i 's total interaction strength) or species strength (sum of dependencies on a species) – are largely based on direct interactions and so do not give a complete picture of B 's role in the three communities in Fig. 1a (Bascompte et al. 2006). Other species-level indices, such as z - and c -scores, do consider indirect interactions, but only with respect to modules (groups of species connected more to each other than to other species in the network). It is important to note that modules and motifs are not equivalent: all networks contain motifs, but not all networks contain modules. This is because motifs have no requirement that their nodes must be more connected to each other than to other nodes in the network, and are simply a decomposition of a network into its constituent subgraphs. z -scores quantify a species' connectivity within modules, while c -scores (also known as the participation coefficient) quantify a species connectivity among modules. In all three networks in Fig. 1a, B has identical c -scores, while z -scores for B are identical in networks I and III. Various centrality indices also incorporate indirect interactions, but rely on the one-mode projection of the bipartite network, where species in one set are linked when they share one or more partners in the other set (Jordán et al. 2007) (Fig. 1b). This compression necessarily leads to a substantial loss of information (Zhou et al. 2007, Saracco et al. 2017). While more sophisticated one-mode projections are available, and these would likely lose less information than the simple projection detailed above, projecting a bipartite network into a unipartite network will always lose some detail. One such detail is that interactions with specialist species such as D will not be considered. This is because specialists only interact with one species and therefore cannot be shared between multiple partners. Given that many one-mode projections are fundamentally based on linking species when they share a partner, singleton species such as D are not accounted for. Consequently, betweenness centrality (the number of shortest paths between two species passing through a focal species) and closeness centrality (the mean shortest path between the focal species and all other species) values for B are identical in all three networks. Finally, even multivariate combinations of common indices describing whole-network structure cannot distinguish between these three situations because all three communities in Fig. 1a have identical connectance, nestedness and modularity.

This is an example of the Goldilocks principle: by accounting for all interactions simultaneously, indices characterising whole-network patterns can be too coarse to detect fine differences. Conversely, by considering too little of the indirect interaction structure, indices describing individual species roles can miss differences beyond their local scope. In both cases, indirect interactions occurring at a level between these whole-network- and species-scales – that is, at the meso-scale – may be missed. This is not to say that network and species-level indices cannot capture any information about indirect interactions. For example, in bipartite networks,

species can be involved in indirect interactions either because they are generalist or because their partner is generalist. Therefore, by measuring the extent to which two sets of species are asymmetrically specialised, nestedness is able to capture aspects of indirect interactions (Bastolla et al. 2009). Similarly, compartmentalisation describes how indirect competition in food webs, or even energy pathways (Zhao et al. 2018), may be constrained to some specific groups (Stouffer and Bascompte 2011). The related species-level metrics (c - and z -scores) highlight how species may contribute to these. Therefore, network and species-level indices can provide useful information on indirect interactions. However, because network and species-level indices are one-dimensional, this information can only capture specific aspects of network structure or a species' role rather than a complete picture of how each species is embedded in the community. Given the importance and ubiquity of indirect interactions, there is room for an alternative framework for describing network structure that uncovers the indirect interactions present in the meso-scale topology of networks.

A framework for indirect interactions

We start by recognising the fact that any given network made up of S species can be broken down into a series of smaller subnetworks containing n species (where $n < S$ and all species have at least one interaction). For example, network I in Fig. 1a includes five subnetworks containing two species ($A-D$, $A-E$, $A-F$, $B-E$, $C-E$) and six subnetworks containing three species ($D-A-E$, $D-A-F$, $E-A-F$, $A-E-B$, $A-E-C$, $B-E-C$). As there are a finite number of ways to arrange interactions between n species, there are also a finite number of possible subnetworks of size n that a network can contain. In other words, all bipartite networks, regardless of their complexity, are assembled from a limited number of parts or building blocks known as 'bipartite motifs' (Baker et al. 2015). For example, Fig. 3 shows all 44 possible motifs containing between two and six species. We argue that an understanding of these basic structural elements captures the details of indirect interactions beyond the global and local features captured by network and species-level indices (Milo et al. 2002).

While motifs are not yet widely adopted in studies of bipartite networks, they have seen much greater uptake for describing indirect interactions in studies of unipartite food webs. Not all unipartite motifs have a simple ecological interpretation, but some represent classic, and well-studied, examples of indirect effects. Figure 2a shows four such motifs. The tri-trophic chain, or trophic cascade, motif represents a situation where the species at the lowest trophic level benefits from the decrease in predation that results from the predator at the top level reducing the abundance of the species in the middle level. In the omnivory or intraguild predation motif, a predator and its prey compete for the same resource. In the apparent competition motif, two prey species share a predator: if one prey species increases in abundance this

can lead to an increase in abundance of the common predator which, in turn, reduces the abundance of the other prey species. Finally, in the exploitative competition motif, two predators compete for the same prey: if one predator reduces the abundance of the shared resource, this indirectly reduces the abundance of the other predator. These simple interaction chains have been used to show that motifs which occur most often in empirical food webs are those which contribute the most to community persistence (Stouffer and Bascompte 2010); that food webs can be regarded as a collection of interconnected motifs in a non-random configuration that enhances biodiversity maintenance (Kondoh 2008); and that simple models of food web structure can reproduce the local topology of networks (Camacho et al. 2007).

As with unipartite motifs, some bipartite motifs have simple ecological interpretations, while others represent more complex situations. For example, some of the classic unipartite motifs have direct bipartite counterparts: when

bipartite networks represent antagonistic interactions, such as herbivory or parasitism, motifs 2 and 3 (Fig. 3) represent apparent competition and exploitative competition, respectively (Fig. 2b–c). When bipartite networks represent mutualistic interactions, these same motifs can represent indirect competitive (Waser 1983, Campbell 1985, Mitchell et al. 2009, Runquist and Stanton 2013, Ye et al. 2014) or facilitative interactions (Moeller 2004, Ghazoul 2006, Liao et al. 2011, Sieber et al. 2011) (Fig. 2d–e). For example, if species P_1 and P_2 in Fig. 2d represent plants, and species A represents a pollinator, plants may be involved in exploitative competition for finite pollinator resources, or interference competition through interspecific pollen deposition (Chittka and Schürkens 2001, Moeller 2004, Mitchell et al. 2009, Flanagan et al. 2010, Hochkirch et al. 2012, Ye et al. 2014). Conversely, facilitative effects can occur where an increase in the abundance of P_1 could indirectly benefit P_2 through providing a beneficial effect to A (Moeller 2004, Sotomayor

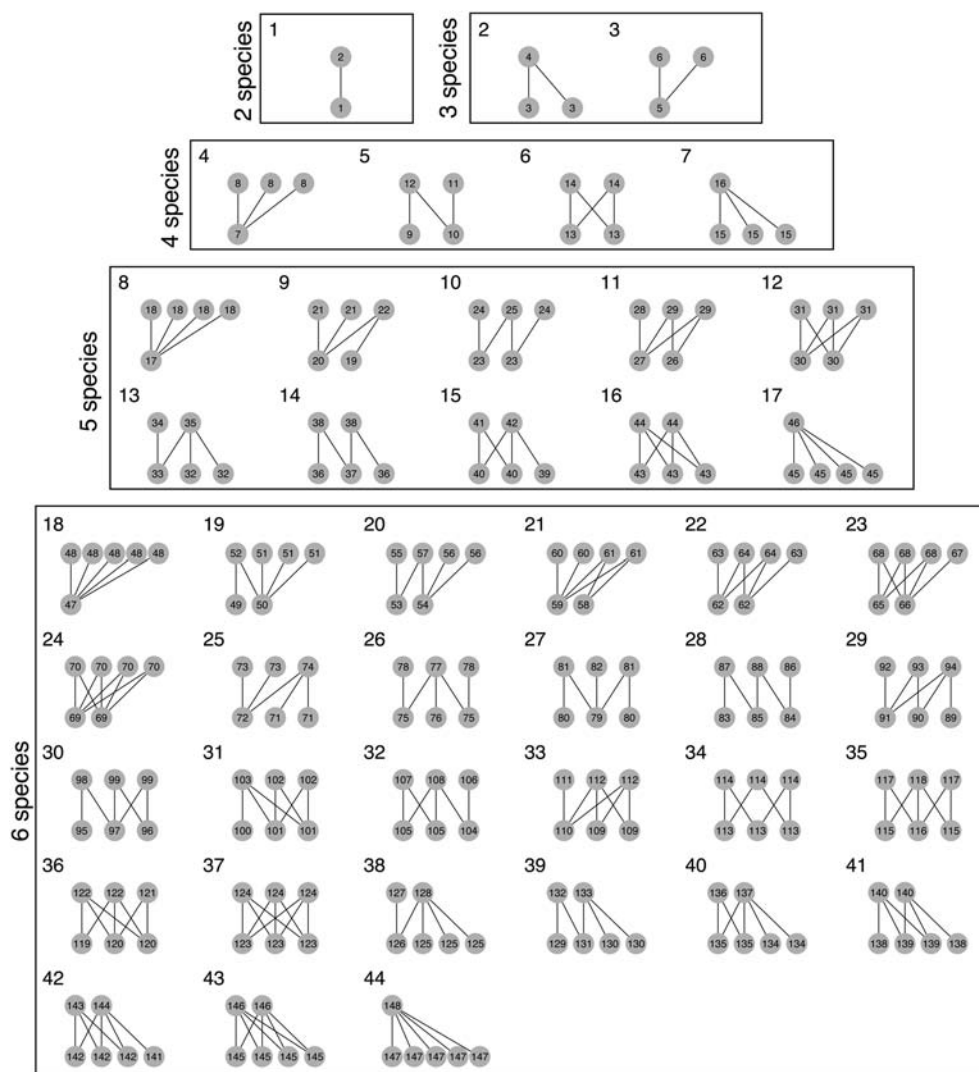

Figure 3. All possible two- to six-species bipartite motifs. Large numbers represent individual motifs. Small numbers within nodes represent unique position within motifs. In total there are 148 positions across 44 motifs.

and Lortie 2015). For example, the presence of one plant species could increase pollinator visits to a coflowering species (Moeller 2004, Ghazoul 2006, Carvalheiro et al. 2014, Ye et al. 2014). A similar situation is found in Fig. 2e, where A_1 and A_2 represent pollinators and P represents a plant species: exploitative and interference competition between pollinators can occur, as can indirect facilitation, where an increase in the abundance of A_1 can provide a beneficial effect to A_2 through P (Rathcke 1983, Temeles et al. 2016). Similar ideas can be applied to other motifs where many specialists interact with a single generalist, such as motifs 4, 7, 8, 17, 18 and 44 (Fig. 3). These motifs extend the implications of the competition motifs discussed above (motifs 2 and 3) to having many species in the specialist group. These ‘fan’ motifs capture situations where all the specialists affect each other indirectly via their effect on the generalist, and are also notable for representing situations where all potential indirect interactions are on the same side of the network, in contrast to other motifs which are more ‘balanced’.

Within motifs, species can occupy different positions (Kashtan et al. 2004). For example, in motif five there are four unique positions, as each species interacts with a unique set of partners (Fig. 3). Considering all bipartite motifs up to six species, there are 148 unique positions (Fig. 3). Note that, due to symmetry, there may be fewer than n unique positions in a motif with n species. For example, in motif six there are only two unique positions, as both species in the top level interact with both species in the bottom level (Fig. 3). Therefore, a bipartite motif with n species can include between 2 and n unique positions. These positions have distinct ecological meanings, with different positions corresponding to species with different direct and indirect interactions (Stouffer et al. 2012, Baker et al. 2015, Cirtwill and Stouffer 2015). Vázquez et al. (2015) highlight this point by detailing some of the different indirect effects that are captured by motif 5 (Fig. 2f, 3). For example, while animal A has a positive direct effect on plant P , A has two negative indirect effects on P , first by providing a beneficial effect to P ’s competitor Q , and second by suppressing animal Y ’s growth rate, which reduces the direct beneficial effect of Y on P (Fig. 2g). Considering the effect of Q on P highlights a similar mix of positive and negative effects (Fig. 2h). Vázquez et al. highlight four interaction pathways. First, Q has a direct short-term negative effect on P due to direct competition. Second, a net positive effect results from the negative of the product between the mutually negative effects of A on Y and the negative effect of Q on P . Third, Q has a positive indirect effect on P through A . Fourth, Q has a negative effect on P by providing beneficial effects to A which suppresses A ’s competitor Y which, in turn, has a negative effect on P . This mixture of positive and negative direct and indirect effects show how interactions between species can mitigate or cancel each other out. While here our focus is on the topology of these interactions, dynamic models or experimentation can be used to determine the overall effects of one species on another (Vázquez et al. 2015).

We can also derive some broad expectations for indirect interactions in motifs with particular structures. For example, in motifs where all species in one group interact with all species in the other group (such as motifs 6, 16, 24, 37, 43), we might expect indirect interactions to be stronger than those in ‘fan’ motifs because they can be transmitted via multiple routes at the same time. However we might also expect dynamics in these ‘complete’ motifs to be less predictable. For example, a decrease in the abundance of a pollinator species in a ‘complete’ motif would decrease the population of all plants in the motif, but also decrease the amount of competition for other pollinators using those plants. For ‘asymmetric complete’ motifs such as 11, 15, 31 and 42, where a specialist species is attached to a group of species which all interact, we might expect that generalists affect the specialists more strongly than vice versa, since the generalists have more choice of interactions and can buffer changes in one partner’s abundance. It is also important to note that, because different trophic groups often live on different timescales, the difference between bottom-majority and top-majority motifs is important. For example, following a decrease in a pollinator species’ abundance, the reduction in competition between pollinators would occur more quickly than a decrease in plant populations.

Above we have provided some examples of how bipartite motifs capture indirect interactions. While a detailed study of all 44 bipartite motifs is beyond the scope of this work, detailed dynamic modelling and interpretation of individual motifs is an important area for future research. Given the large number of papers that have been dedicated to studying individual motifs in unipartite food webs, we anticipate that this is a fruitful area for further studies. Ultimately, motifs are a way to capture the topology of interaction chains explicitly. Considering up to six-node motifs as we do here, this means that motifs can capture interaction chains with up to four intermediary species between the donor and recipient species. For example, Supplementary material Appendix 3 Fig. A5 shows how even a small five-species motif captures 28 interaction chains.

We have discussed how motifs relate to indirect interactions, but it is also important to detail how motifs can actually be used to characterise the structure of ecological networks and their constituent species. To characterise network structure in the motif framework, networks are first decomposed into their constituent motifs, giving an inventory of the parts which make up the network. These simple lists show the frequency c_i with which each motif i occurs in a network. This provides an m -dimensional ‘signature’ of a network’s structure, given by the vector $\vec{c}_i = \{c_1, c_2, \dots, c_m\}$, where m is the number of motifs counted. For example, Fig. 4 shows the constituent motifs of each example network from Fig. 1 and Fig. 5a shows the structural signature of each of these networks. When viewed in this way, it becomes clear that each of these communities is made up of different parts, despite having similar or identical values of several common network-level indices.

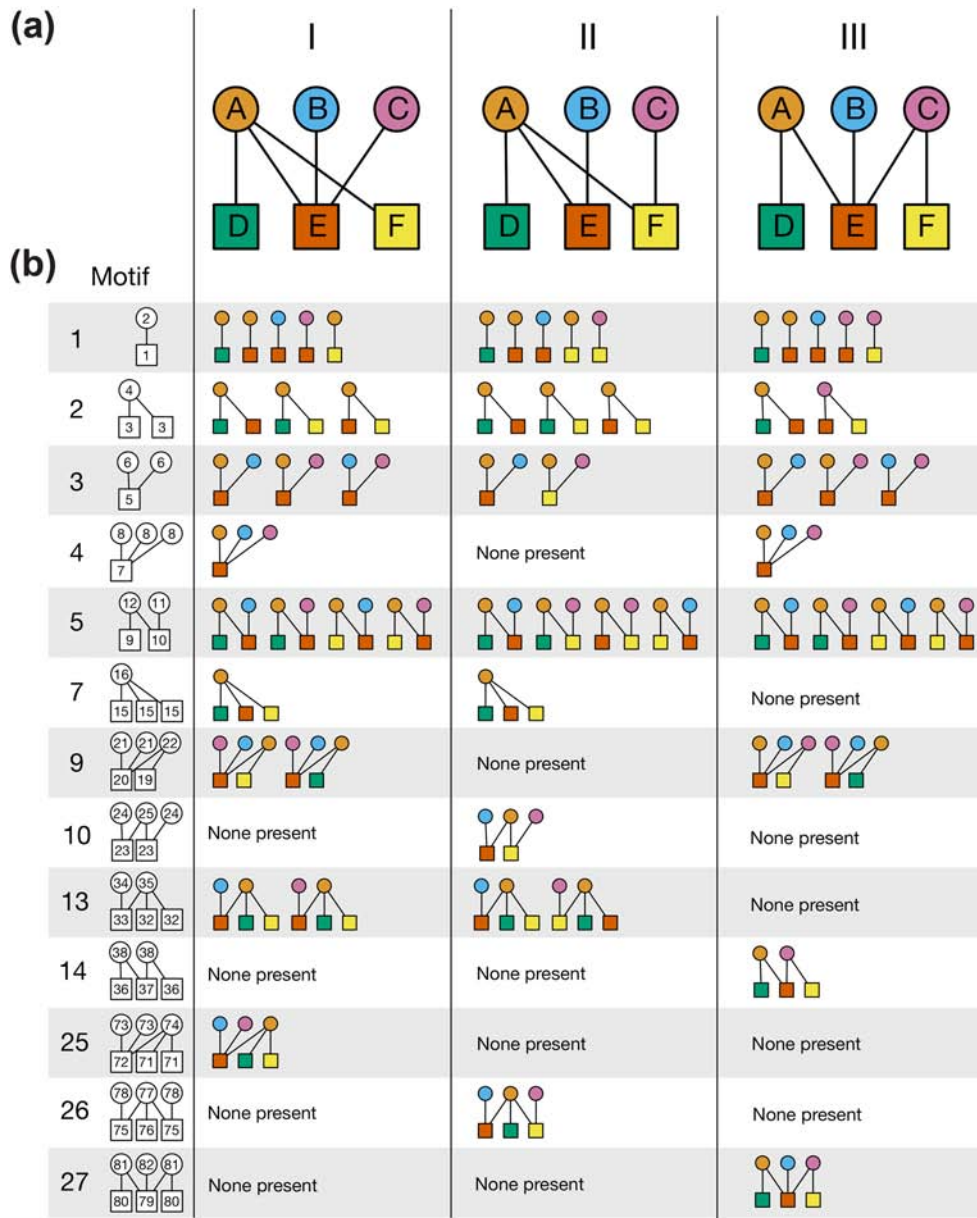

Figure 4. Decomposing three example networks into their constituent two- to six-node motifs. (a) Three example networks also used in Fig. 1a. (b) Table showing each network's constituent motifs. The first column shows the motif being counted: the large number refers to the ID of the motif as given in Fig. 3; the small number within each node refers to the unique positions species can occupy within each motif as given in Fig. 3. The second, third and fourth columns show the occurrences of each motif in networks I, II and III respectively. Node colours refer to the species involved in each motif. For visualisation purposes, we exclude motifs which do not occur in any network, such as motif 8.

As noted above, species can occupy different positions within motifs. As these positions have distinct ecological meanings, a species' role in a network can be defined by the frequency with which it occurs in each position (Stouffer et al. 2012, Baker et al. 2015, Cirtwill and Stouffer 2015). For example, Fig. 4b shows how, in network I, species *B* occurs once in position two, twice in position six, once in position eight, and so on. Generally, therefore, species roles are described by a vector $\vec{r}_{xy} = \{r_{x1}, r_{x2}, \dots, r_{xp}\}$, where r_{xy}

is the frequency with which species *x* occurs in position *y* and *p* is the number of positions counted. This vector can be thought of as a *p*-dimensional signature of a species' role, or its multidimensional 'interaction niche'. Figure 5b shows the role signature of species *B* in the three networks from Fig. 1a. The roles are different in each network, demonstrating how this framework, by capturing indirect interactions at the meso-scale, distinguishes species roles that many network and species-level indices could not. Additionally, this

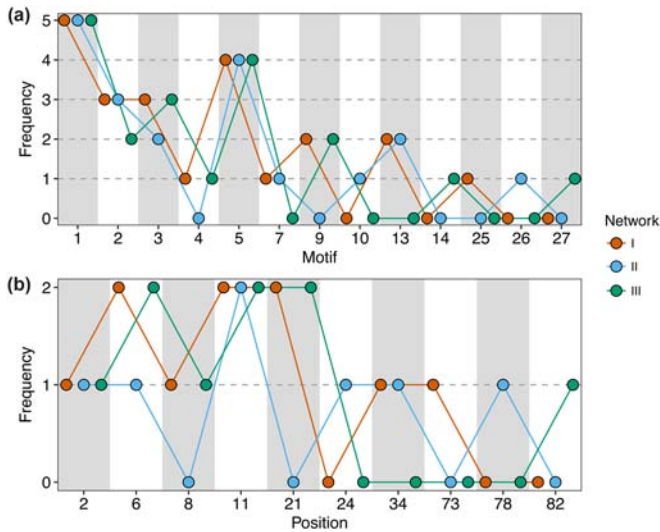

Figure 5. Motif and position frequencies of networks I, II and III from Fig. 1a and Fig. 4a. (a) The frequency with which each motif occurs in each network. For visualisation purposes, we exclude motifs which do not occur in any network. (b) The frequency with which species *B* occurs in each unique position within motifs in each network. For visualisation purposes, we exclude positions within which species *B* does not occur in any network. Motif and positions IDs correspond to those given in Fig. 2 and 4.

did not require an a priori selection of the particular aspect of network structure to examine for differences; rather the approach is general, simply providing a detailed view of how *B* is embedded in the community.

Here we have considered bipartite motifs containing between 2 and 6 species. Studies of unipartite networks usually consider only three-species motifs (Kondoh 2008, Stouffer and Bascompte 2010, Stouffer et al. 2012, Borrelli 2015). Since interactions in these unipartite networks are directed, there are 13 possible three-species motifs which alone can provide a good description of meso-scale network structure (Milo et al. 2002). Conversely, in the undirected bipartite networks we consider here, only two three-species motifs exist (Fig. 3), and therefore only considering motifs of this size would not capture much information about how interactions are distributed in networks. Similarly, while there are 199 possible four-node motifs in directed unipartite networks, there are only four in undirected bipartite networks (Fig. 3). Therefore, for undirected bipartite networks, it is important to consider larger motifs in order to adequately capture meso-scale structure (Baker et al. 2015, Cirtwill et al. 2018).

Motifs can be of any size and a completely lossless description of network structure would require counting motifs containing up to n nodes, where n is the number of nodes in the network. However, this would be analytically intractable for all but the smallest networks as it would involve a vast number of different motifs and be very difficult to enumerate. Therefore it is necessary to decide the maximum size of motifs to be included in a given analysis, given the

computational and methodological constraints involved in counting larger motifs. These computational and methodological considerations are particularly important for modern network research where analyses involving large numbers of calculations are common, such as using ensembles of null networks to control for network size and connectance. There is therefore a tradeoff between capturing more structural detail with larger motifs, and the methodological and computational challenges associated with the discovery and counting of larger motifs and their constituent motif positions. We are not aware of any studies using bipartite motifs of more than six nodes. Additionally, to our knowledge, motif positions have never been defined for motifs greater than six nodes. Therefore, while more information may be embedded in 7-, 8- or 9-species motifs, and so on, 6-species motifs strike a useful balance between capturing detail and being analytically tractable. Determining whether incorporating larger bipartite motifs adds significantly more information is an important area for future research, especially as computational capacity continually improves. Whatever the maximum size used, we note that a significant pattern at n species necessarily implies a pattern at sizes greater than n because they are composites of the level below.

Comparing network- and species-level indices to motifs

In Fig. 1, 4 and 5, we used simple six-species networks to demonstrate how network and species-level indices can mask potentially important meso-scale variation in indirect interactions. Here we generalise this effect to a large ensemble of networks of varying sizes and structures using simulations. We first generated 20 000 bipartite networks containing 6 to 50 species in each set (giving 12 to 100 species) and with connectances ranging between the minimum required for each species to interact with at least one partner and 0.5. Networks were generated using the bipartite cooperation model (Saavedra et al. 2009). We chose this model because cooperative interactions are one of the main types of interaction represented as bipartite networks in ecology, with pollination and seed dispersal being two of the most popular examples (Bascompte and Jordano 2007). For our analysis, we needed to generate many networks with a range of structures, but we also wanted these networks to be realistic. The bipartite cooperation model was therefore suitable because it reproduces many important structural features of empirical ecological cooperative networks (Saavedra et al. 2009).

Network level

We characterised the structure of each of the 20 000 networks at the macro-scale, using three whole-network indices (connectance, nestedness, modularity). Nestedness was measured as NODF (Almeida-Neto et al. 2008) and modularity was calculated using the ‘computeModules’ function from the ‘bipartite’ R package (Dormann et al. 2009, Beckett 2016, <www.r-project.org>). We ranked networks according to each macro-scale index (connectance, nestedness, and modularity) in turn and divided networks

into subsets of 50 according to this ranking. For example, when ranking networks by connectance there would be 400 subsets, each containing 50 networks with similar values of connectance.

For each network in each subset, we characterised its structure at both the macro- and meso-scale. At the macro-scale, networks were described with a vector containing the number of species in the first set, the number of species in the second set, and two of connectance, nestedness, and modularity (having excluded the metric used for ranking networks). For example, if connectance was used as the ranking property, the macro-scale structure vector would include the number of species in the first set, the number of species in the second set, nestedness and modularity. At the meso-scale, network structure was described using the frequencies of motifs containing between three and six species, \bar{c}_i , as described above. Motif frequencies were calculated using the ‘bmotif’ R package (Simmons et al. 2018). We excluded the two-species motif representing a direct interaction between two species because the focus here is on indirect interactions.

For each subset, we calculated pairwise distances between all network structural vectors at both the macro- and meso-scale. At the macro-scale, we calculated distances between networks’ macro-scale vectors, while at the meso-scale we calculated distances between networks’ meso-scale vectors. Distances were calculated using the ‘correlation’ distance measure in the ‘rdist’ function from the ‘rdist’ R package (Blader 2018). This converts correlations ranging between -1 and 1 to distances ranging between 0 and 1 , following $\sqrt{(1 - r) / 2}$, where r is the correlation between two vectors. To control for the possibility that some subsets might have more variable structure than others, we then normalised distances by dividing by the maximum distance between any two networks, giving values between 0 (for identical networks) and 1 (for completely different networks).

For each subset, we then calculated the distance between each network’s macro- or meso-scale structural vector and the subset centroid representing the ‘typical’ structure for each

subset. These distances were calculated using the ‘betadisper’ function from the ‘vegan’ R package (Oksanen et al. 2016). Again, this was done separately for each scale: for the macro-scale analysis, the ‘betadisper’ function was fed the distance-based object based on the macro-scale vectors, while for the meso-scale analysis, the function was fed the distance-based object based on the meso-scale vectors.

We repeated this procedure using each of connectance, nestedness, and modularity as the ranking variable, to give three views of the variability of network structure at macro- and meso-scales. We then used paired Wilcoxon signed-rank tests to compare the differences in variation between macro- and meso-scale subsets.

The median paired differences in variation between macro- and meso-scale subsets were 0.13 (Wilcoxon: $p < 0.0001$) when ranked by connectance, 0.12 (Wilcoxon: $p < 0.0001$) when ranked by nestedness and 0.13 (Wilcoxon: $p < 0.0001$) when ranked by modularity. These results show that, for a given level of connectance, nestedness or modularity, networks that appear similar at the macro-scale can be composed of different interaction structures: meso-scale structural signatures based on motifs generally showed significantly more dissimilarity than macro-scale measures of structure (Fig. 6). Specifically, for connectance, nestedness and modularity as the ranking variable respectively, the motif framework captured 69%, 62% and 57% more variation in network structure on average than traditional whole-network indices.

Nestedness, modularity and motif frequencies can vary with network size and connectance. To control for this effect, we repeated the above analysis using a null model approach, where nestedness, modularity and motif frequencies were expressed relative to a suite of null networks that preserve some basic network properties (Supplementary material Appendix 1). Our results and conclusions from this analysis were qualitatively identical. Overall, therefore, the increased variation in indirect interactions highlights the problem of describing network structure by its macro-scale properties alone.

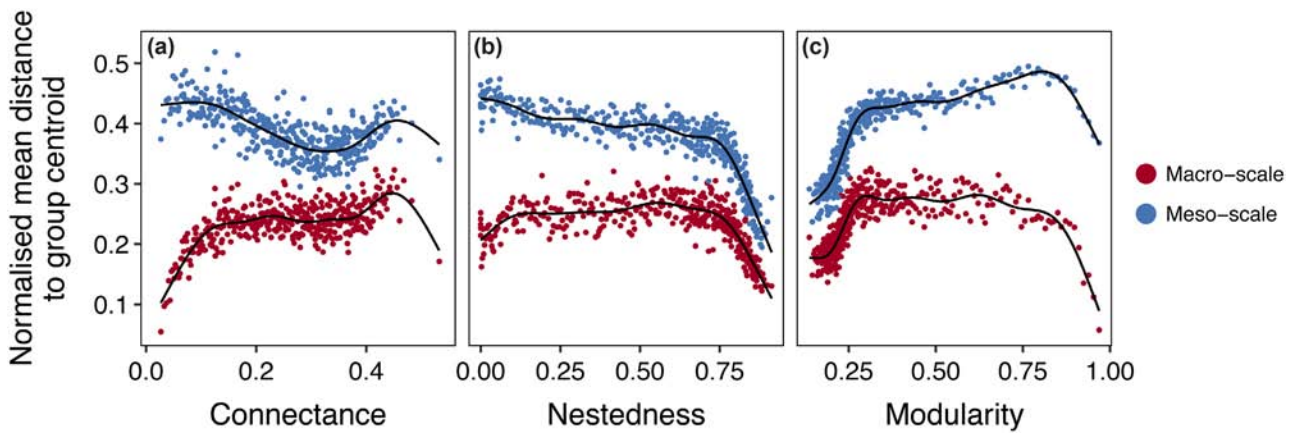

Figure 6. Network variation (normalised mean distance to group centroid) against mean connectance (a), nestedness (b) and modularity (c) for all networks. Points represent subsets of 50 networks.

Species level

The above analysis compares meso- and macro-scale approaches. However, it is also important to understand how meso-scale descriptors relate to species-level (micro-scale) indices. We therefore conducted a similar analysis to that described above, but compared motifs to species-level indices instead of network-level indices.

Using five complementary species-level indices (degree, closeness centrality, betweenness centrality, c -score and z -score) (Emer et al. 2016), we characterised the roles of 55 094 species across 1000 networks generated using the bipartite cooperation model. Degree, closeness centrality and betweenness centrality were calculated using the ‘bipartite’ R package (Dormann et al. 2009), while c - and z -scores were calculated using the ‘rnetcarto’ R package (Doulcier and Stouffer 2015). We ranked species according to each micro-scale index (degree, closeness, centrality, betweenness centrality, c -score and z -score) in turn and divided species into subsets of 50 according to this ranking. For example, when ranking species by closeness centrality each subset would contain 50 species with similar values of closeness centrality.

For each species in each subset, we characterised its role at both the micro- and meso-scale. At the micro-scale, species roles were described with a vector containing four of degree, closeness centrality, betweenness centrality, c -score and z -score (having excluded the metric used for ranking species). For example, if degree was used as the ranking property, the micro-scale structure vector would include closeness centrality, betweenness centrality, c -score and z -score. At the meso-scale, species roles were characterised with the vectors describing the frequency with which species occur in all unique positions across motifs containing between three and six species. Species motif roles were calculated using the ‘bmotif’ R package (Simmons et al. 2018).

For each subset, we calculated pairwise distances between all species role vectors at both the micro- and meso-scales, using the ‘correlation’ distance measure in the ‘rdist’ function from the ‘rdist’ R package (Blader 2018). Distances were normalised by dividing by the maximum distance between any two species, giving values between 0 (for identical species) and 1 (for completely different species).

Finally, for each subset at each scale, we calculated the distance between each species’ micro- or meso-scale role vector and the subset centroid representing the ‘typical’ structure for each subset using the ‘betadisper’ function from the ‘vegan’ R package (Oksanen et al. 2016).

We repeated this procedure using each of degree, closeness centrality, betweenness centrality, c -score and z -score as the ranking variable, to give five views of the variability of species roles at micro- and meso-scales. We then used paired Wilcoxon signed-rank tests to compare the differences in variation between micro- and meso-scale subsets.

The median paired differences in variation between micro- and meso-scale subsets were 0.16 when ranked by degree (Wilcoxon: $p < 0.0001$), 0.32 when ranked by closeness centrality (Wilcoxon: $p < 0.0001$), 0.34 when ranked by

betweenness centrality (Wilcoxon: $p < 0.0001$), 0.44 when ranked by c -score (Wilcoxon: $p < 0.0001$) and 0.40 when ranked by z -score (Wilcoxon: $p < 0.0001$). These results show that, for a given level of degree, closeness centrality, betweenness centrality, c -score or z -score, species that appear to have similar roles at the micro-scale can be embedded in networks in very different ways: meso-scale structural signatures based on motifs generally showed significantly more dissimilarity than micro-scale measures of structure (Fig. 7). Specifically, for degree, closeness centrality, betweenness centrality, c -score or z -score as the ranking variable respectively, the motif framework captured 83%, 406%, 465%, 1076% and 610% more variation on average than traditional species-level indices. Overall, therefore, this increased variation in interaction structure highlights the problem of describing species roles by their micro-scale properties alone.

Robustness to sampling effort

A major challenge among studies of ecological networks is that completely sampling a web of interactions is difficult: both species and their interactions can be missed, especially if they are rare or hard to detect (Jordano 2016). Many network and species-level indices are sensitive to sampling effects (Dorado et al. 2011, Rivera-Hutinel et al. 2012, Fründ et al. 2016). To assess the sensitivity of the motif framework to sampling biases, we simulated different levels of sampling effort on 40 empirical, quantitative pollination and seed dispersal networks obtained from the Web of Life repository (<www.web-of-life.es>; Supplementary material Appendix 3 Table A1). The inclusion criteria we used for selecting these networks are as follows. We started with all 119 quantitative pollination and seed dispersal networks currently available from the Web of Life repository. We first removed networks which were part of a timeseries of networks from the same location (rather than independent datasets) to avoid pseudo-replication. This reduced the dataset to 47 networks. We then only included networks with more than five species in each level of the bipartite network (for example, five or more pollinators and five or more plants), to ensure that five-species motifs could be calculated for all datasets. This resulted in a dataset of 42 networks. Finally, we removed two very large networks for which it was computationally infeasible to carry out our analysis, leaving a final dataset of 40 networks. In field studies, plant-animal interaction networks are usually sampled by observing plants and recording the animals that visit them (Jordano 2016). To replicate this process in silico, we sampled networks in two stages (de Aguiar et al. 2017). First, we sampled a proportion, p , of plant species to simulate the likely scenario that not all plant species are observed when surveying a site (Jordano 2016). Species with more partners had a higher chance of being sampled, as generalist species tend to be more abundant in mutualistic communities (Fort et al. 2016; though see Supplementary material Appendix 3 Fig. A6 for results where species had a random probability of being selected). Second, for each selected plant

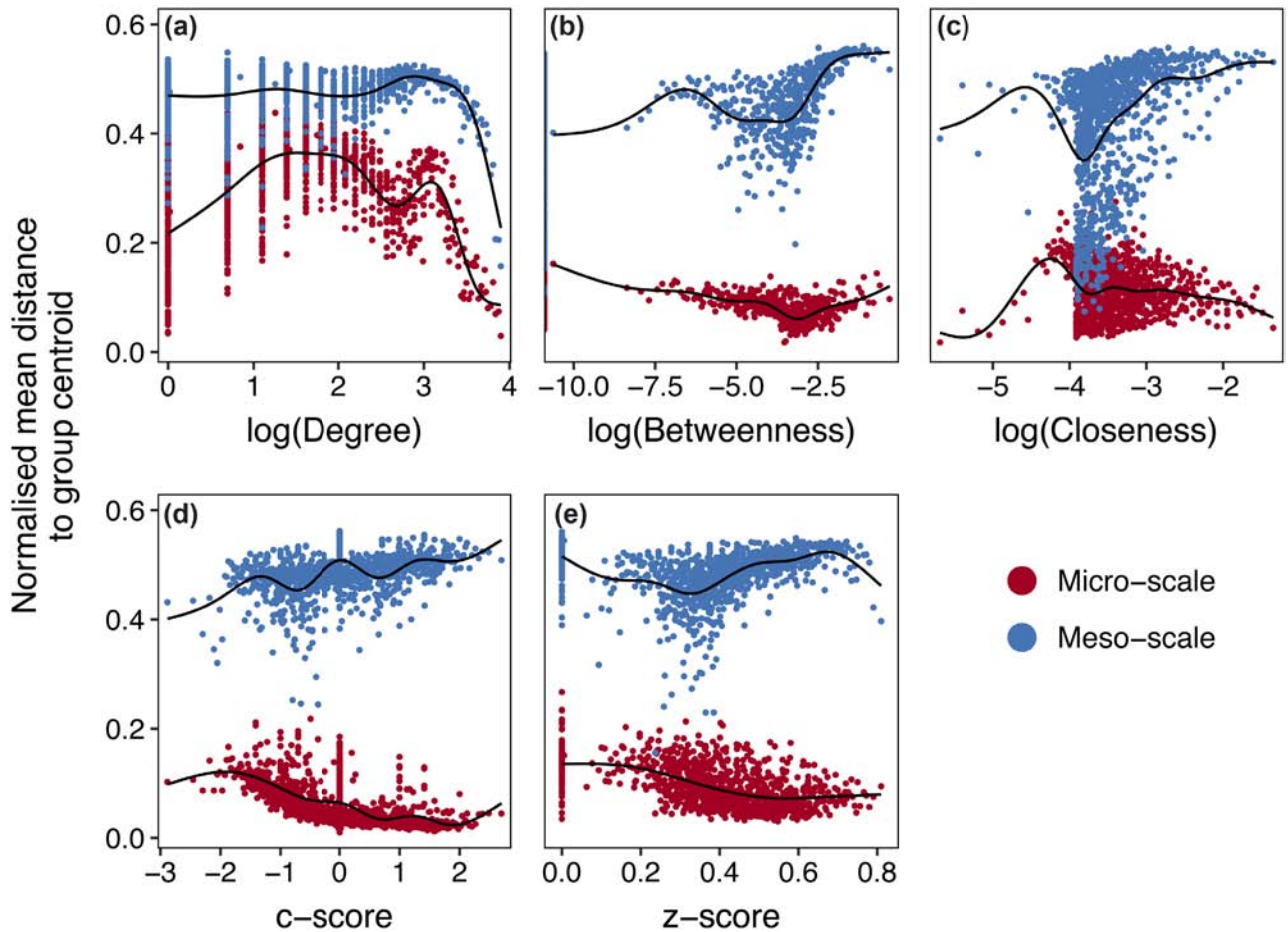

Figure 7. Species role variation (normalised mean distance to group centroid) against mean degree (a), betweenness (b), closeness (c), c -score (d) and z -score (e) for 55 094 species across 1000 networks. Points represent subsets of 50 species.

species, we sampled a proportion, q , of their interactions to simulate the fact that not all interactions are observed (Dormann et al. 2009, Poisot et al. 2012); stronger interactions, corresponding to more frequent visits between plants and animals, had a higher probability of being sampled (de Aguiar et al. 2017). We repeated this process for different values of p and q between 0.5 and 1, performing 1000 randomisations at each p - q combination. This choice of threshold was partly dictated by the constraints of the dataset: when more than 50% of species and 50% of links were removed, most networks became disconnected and trivial, meaning that motifs of larger size classes often did not occur. However, a 50% sampling threshold is also a realistic one for many networks: in several studies that have measured the sampling completeness of networks, over 50% of species and interactions are often recorded. (Chacoff et al. 2012, Devoto et al. 2012, Traveset et al. 2015). Therefore while we are sure some sampled networks contain less than 50% of the ‘true’ number of species or interactions, this does not seem to be such a widespread phenomenon as to make our choice of a 50% threshold unrealistic or unhelpful. Instead, many sampled networks are estimated to contain more than 50% of interactions and species.

We decomposed each sampled network into its constituent motifs and recorded each network’s motif structural signature and the motif role signatures of each species. We then measured R^2 between the network structural signature or species role signature of the sampled network and those of the corresponding ‘true’ network containing all species and interactions. Further details of the simulations are given in the Supplementary material Appendix 3. We found that both network structural signatures and species role signatures were remarkably robust to sampling effects. Even when only 50% of plant species and 50% of their interactions were sampled, the mean R^2 between the sampled and ‘true’ network signatures was 0.87 (Fig. 8a). At this same level of sampling, the mean R^2 between sampled and ‘true’ species role signatures was 0.93 (Fig. 8b). That motifs appear robust to sampling effects is encouraging for future studies adopting this framework.

Indirect interactions in empirical plant–pollinator networks

Here we present a case study comparing the roles of two pollinator species over time. Data was from four mountaintop plant–pollinator communities in the Seychelles, sampled over

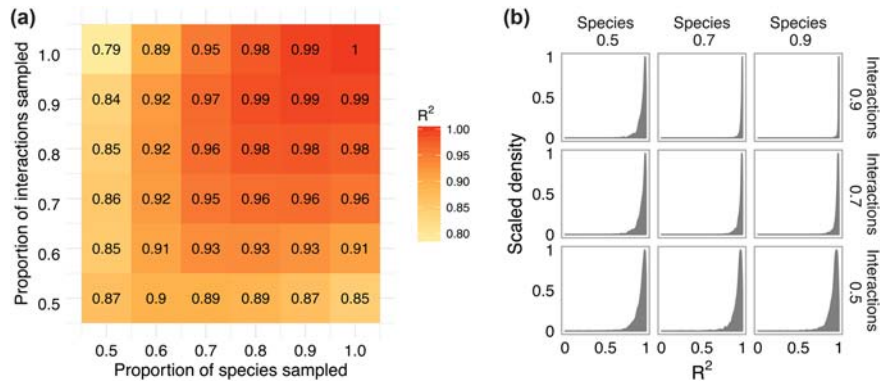

Figure 8. Results of simulations assessing the sensitivity of the motif framework to variation in sampling effort. (a) The mean R^2 between the network structural signatures of the sampled networks and the structural signatures of their corresponding ‘true’ networks, for different levels of species and interaction removal. (b) Distribution of mean R^2 between species role signatures in sampled networks and species role signatures in their corresponding ‘true’ networks, for different levels of species and interaction removal.

the flowering season in eight consecutive months between September 2012 and April 2013 (Kaiser-Bunbury et al. 2017; Supplementary material Appendix 3 Table A2). Restoration by removal of exotic plants from these communities resulted in pollinator species becoming more generalised. This pattern was driven largely by two abundant, highly generalist pollinator species, one native (*Lasioglossum mahense*) and one non-native (*Apis mellifera*) (Kaiser-Bunbury et al. 2017). These two abundant, super-generalist species could have similar strategies for partner selection and therefore play similar roles in the community. This is the result found in the original study where both species had similar levels of specialisation (quantified using the specialisation index d' , which measures the extent to which species deviate from a random sampling of available partners (Blüthgen et al. 2006)): 0.17 ± 0.10 and 0.22 ± 0.18 for *L. mahense* and *A. mellifera* respectively. Alternatively, two abundant, super-generalists could minimise competition by exploiting different areas of ‘interaction niche space’ and therefore have different roles. To test these alternatives, we calculated the motif role signatures of both species at each site in each monthly network, giving a detailed view of how each species is embedded in the community over time. We used permutational multivariate analysis of variance (PERMANOVA), stratified by site, to assess if there are significant differences between the roles the two species play in the four communities. PERMANOVA is similar to ANOVA but compares multivariate differences within and between groups without assuming normality or Euclidean distances (Anderson 2001). We used Bray–Curtis distance as the dissimilarity measure, as it is suitable for a variety of ecological data, including motifs (Faith et al. 1987, Anderson and Robinson 2003, Baker et al. 2015). PERMANOVAs were run with 10 000 permutations.

The PERMANOVA analysis showed that *L. mahense* and *A. mellifera* had significantly different roles over time ($F_{1,62}$, $p=0.0496$), exploiting different areas of interaction niche space. This means that, while Kaiser-Bunbury et al. (2017) used the species-level metric d' to show that both species were super-generalists, a motif approach reveals that they are

generalist in different ways. This result is visualised in Fig. 9. More positive values of the first NMDS axis are associated with motif positions where more specialist pollinators compete with generalist pollinators for a shared plant resource, while negative values are associated with positions where generalist pollinators visit specialist plants with little competition. More positive values of the second NMDS axis are associated with positions where pollinators visit plants which are also visited by generalist species; negative values are associated with positions where pollinators visit plants which are also visited by specialist species. *Lasioglossum mahense* generally occupies higher values of both NMDS axes than *A. mellifera*. Therefore, while both species are generalists, *L. mahense* is in greater competition with generalist pollinators than *A. mellifera* which visits more specialist plants and competes with more specialist pollinators. These differences in indirect interactions are essential for understanding the ecology of these two species and are missed using the d' index alone. All PERMANOVA tests and NMDS analyses were conducted in the R package ‘vegan’ (Oksanen et al. 2016).

Potential applications

Characterising the structure of species interaction networks is a key component of many areas of ecological research, such as robustness to extinctions (Kaiser-Bunbury et al. 2010), ecosystem functioning (Coux et al. 2016) and macroecology (Araújo and Luoto 2007, Staniczenko et al. 2017). It is essential to incorporate indirect interactions into all these analyses, suggesting that the framework presented here has wide applicability to a diverse range of topics, systems and interaction types. In particular, we suggest the motif framework may be beneficial for studies where the scale of interest is at the species level, such as examining how invasive species integrate into communities (Vilà et al. 2009, Stouffer et al. 2014); or when within-network phenomena are the focus, such as studies of rewiring and network variability over time (Olesen et al. 2008, Kaiser-Bunbury et al. 2010). As indirect interactions are likely to be of increased

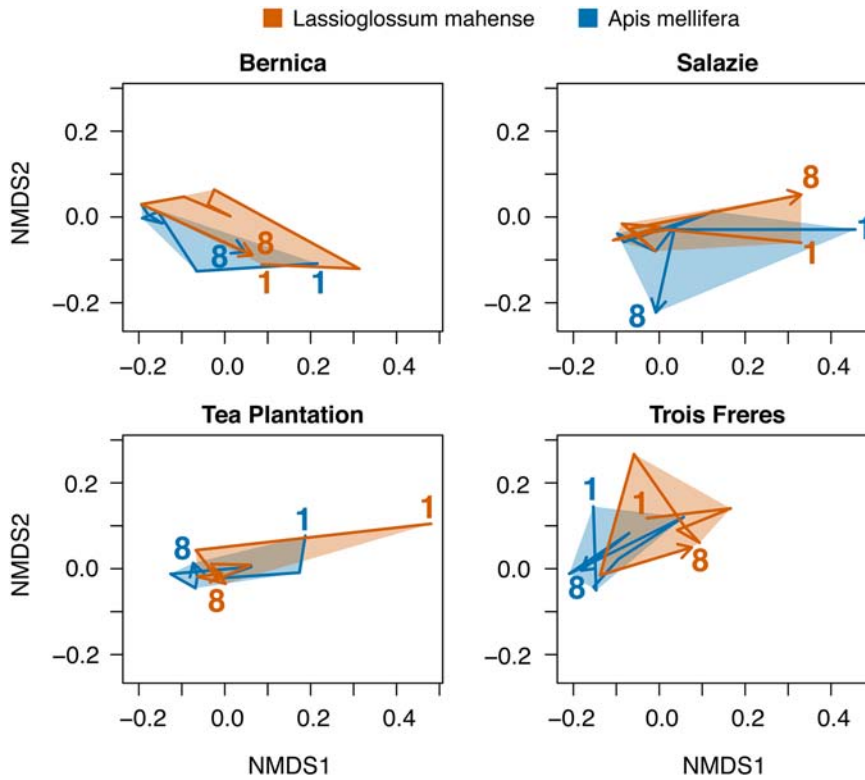

Figure 9. The movement of *Lasioglossum mahense* and *Apis mellifera* through interaction niche space over eight months in four sites (Bernica, Salazie, Tea Plantation and Trois Freres). Each vertex represents the role of a species in a monthly network. Numbers ‘1’ and ‘8’ indicate the first and last sampling month, respectively. Shaded polygons are convex hulls containing the vertices of each species.

importance when investigating these types of questions, we caution against using only conventional network and species-level indices which can mask detail about these interactions. Adopting motif descriptions of network structure also opens up new ways to answer a diverse range of questions such as those concerning competitive exclusion, species packing and functional redundancy (Blonder et al. 2014). For example, does interaction distinctiveness correlate with functional distinctiveness? Do species have overlapping or disjoint roles? Do indirect interaction structures vary over space and time?

We have shown how easy it is for similar-looking networks to be composed of very dissimilar parts. We therefore expect that much valuable information on network structure has been ignored, intentionally or unintentionally. This realisation yields a series of hypotheses about how our understanding of bipartite ecological networks may change if this extra information was incorporated. For example, uncovering indirect interactions could revise our understanding of how invariant network structure is across space and time. Several studies have shown that network structure is relatively stable in the presence of temporal and spatial turnover in species and interaction identity (Petanidou et al. 2008, Dáttilo et al. 2013). However, these studies have considered only global descriptors of structure that likely mask meso-scale structural variation in indirect interactions. We anticipate that, if indirect interactions were considered, network structure may

not be as invariant to compositional turnover as previously identified.

We also hypothesise that incorporating indirect interactions may improve predictions of network structure and our understanding of the mechanisms underpinning network assembly. Understanding the processes that govern the formation of species interactions is essential for predicting the structure of novel communities under global changes (Eklöf et al. 2013). However, current attempts often involve assessing how well different mechanisms, such as neutral effects, morphological matching and phenological overlap, predict different network and species-level indices (Vázquez et al. 2009, Verdú and Valiente-Banuet 2011, Sayago et al. 2013, Vizentin-Bugoni et al. 2014). For example, Vázquez et al. (2009) show that data on abundance and phenology can accurately predict network-level indices such as connectance and nestedness. This approach is problematic because many network and species-level indices are insensitive to changes in network topology. Models can therefore accurately predict index values while incorrectly predicting pairwise interactions (Fox 2006, Olito and Fox 2015). Such models may be of limited utility in helping to understand the processes underlying network structure. To improve models, structural signatures based on motifs could be used instead as a benchmark of predictive performance. As the motif framework is much more sensitive to changes in network topology than network and species-level indices are, it would be harder for models to accurately

predict a structural signature while incorrectly predicting pairwise interactions. We therefore expect that adopting the motif framework could change both our understanding of the processes governing interactions and improve our ability to predict novel communities.

Finally, incorporating indirect interactions could improve understanding of the functional consequences of community structure (Thompson et al. 2012, Poisot et al. 2013). For example, pollinators with more distinct traits (traits furthest from the community average) tend to have fewer interaction partners (Coux et al. 2016). One hypothesis for this pattern is a trade-off between reducing competition with other pollinators by having original traits and needing to retain interaction partners (Vamosi et al. 2014, Coux et al. 2016). The motif framework could explicitly test this hypothesis by assessing whether functionally original species appear primarily in motif positions where there is low competition between pollinators.

Limitations and challenges

Currently, bipartite motifs have only been used for qualitative networks, where interactions are present or absent. This contrasts with quantitative networks where interactions are weighted in proportion to their relative strength. Using only qualitative information, rare species or interactions can exert a disproportionate influence on network metrics (Banašek-Richter et al. 2004). The loss of detail on indirect interactions resulting from the use of conventional network and species-level indices is, however, likely to be equal to or greater than the loss of information resulting from using qualitative instead of quantitative networks. As shown in the example above, d' , an index which uses quantitative information on interaction weights, could not distinguish the roles of *L. mahense* and *A. mellifera*, while qualitative motifs could. We also note that qualitative versions of many conventional metrics (such as connectance and degree) are frequently used to characterise quantitative networks instead of their weighted counterparts. While methods to enumerate weighted motifs are being developed (Bramon Mora et al. 2018), there are a number of tractable methods to incorporate quantitative information in motif analyses. For example, interactions within motifs can be classified as 'strong' or 'weak' depending on whether a given interaction's strength is greater or lesser, respectively, than the median strength (Rodríguez-Rodríguez et al. 2017). Alternatively, a suite of qualitative networks can be assembled by sampling a quantitative network in proportion to the strength of each interaction (Baker et al. 2015). This creates an ensemble of qualitative resampled networks where stronger interactions appear more frequently than weaker ones. Analyses can then be repeated using each of the resampled networks as input. This creates a distribution of p-values or effect sizes associated with a particular analysis, which can then be compared to the results obtained using a binary version of the original quantitative network.

Finally, it is important to note that, like network and species-level indices, the motif framework also results in a loss of information when characterising network structure: transforming a network into a structural signature or ensemble of species' role signatures is unique, while the reverse is not. Some loss of information is inevitable so long as we must summarize networks in order to analyse them. However, motifs are substantially less interaction inelastic than network and species-level indices, and therein lies their advantage.

Concluding remarks

Indirect interactions are a widespread and important component of ecological communities, essential for understanding species roles and the structure of biotic interactions. However, to date the dominant paradigm has been to describe community structure using a wide variety of network and species-level indices that can mask indirect interaction detail. Here we have presented a framework that conceptualises networks as a series of component building blocks or 'motifs'. By thinking of networks in this way, we have shown that potential indirect interactions can be explicitly identified and quantified. We do not advocate widespread abandonment of network and species-level indices, but instead aim to raise awareness of their limitations. We hope that motifs will exist alongside network and species-level indices to form the basis of a new paradigm among studies of bipartite ecological networks. Given the increasingly large amount of ecological network data available, and the rapid growth in computational capacity to analyse these data, there is now a timely opportunity to make motifs a standard part of the analytical toolkit for studying bipartite systems. Such an approach could enable novel perspectives and insights into the ecology and evolution of many important communities.

Acknowledgements – BIS thanks Stephen Simmons and Eleanor Tew for useful discussions.

Funding – BIS is supported by the Natural Environment Research Council as part of the Cambridge Earth System Science NERC DTP [NE/L002507/1]. ARC, NJB, and DBS were all supported by Marsden Fund Fast-Start grant UOC-1101, administered by the Royal Society of New Zealand. NJB was also supported by a BlueFern HPC PhD scholarship and DBS by a Rutherford Discovery Fellowship, also administered by the RSNZ. ARC was also supported by a Formas grant (no. 942-2015-1262, awarded to Anna Eklöf). HSW was supported by a Cambridge Trust Cambridge-Australia Scholarship and a Cambridge Department of Zoology JS Gardiner Fellowship. LVD was supported by the Natural Environment Research Council (grants NE/K015419/1 and NE/N014472/1). WJS is funded by Arcadia.

Author contributions – BIS conceived the study, performed analyses and wrote the first draft of the manuscript. BIS, ARC and DBS designed analyses and interpreted results. BIS, ARC and NJB performed the analysis demonstrating meso-scale dissimilarity in networks with similar macro-scale properties. HSW assisted with analyses. All authors contributed to writing the manuscript.

Data accessibility

All analyses in this manuscript use open access data which are already archived in public repositories.

References

- Almeida-Neto, M. et al. 2008. A consistent metric for nestedness analysis in ecological systems: reconciling concept and measurement. – *Oikos* 117: 1227–1239.
- Anderson, M. J. 2001. A new method for non parametric multivariate analysis of variance. – *Austral Ecol.* 26: 32–46.
- Anderson, M. J. and Robinson, J. 2003. Generalized discriminant analysis based on distances. – *Aust. N. Z. J. Stat.* 45: 301–318.
- Araújo, M. B. and Luoto, M. 2007. The importance of biotic interactions for modelling species distributions under climate change. – *Global Ecol. Biogeogr.* 16: 743–753.
- Bailey, J. K. and Whitham, T. G. 2007. Biodiversity is related to indirect interactions among species of large effect. – In: Ohgushi, T. et al. (eds), *Ecological communities: plant mediation in indirect interaction webs*. Cambridge Univ. Press, pp. 306–328.
- Baker, N. J. et al. 2015. Species' roles in food webs show fidelity across a highly variable oak forest. – *Ecography* 38: 130–139.
- Banašek-Richter, C. et al. 2004. Sampling effects and the robustness of quantitative and qualitative food-web descriptors. – *J. Theor. Biol.* 226: 23–32.
- Bascompte, J. and Jordano, P. 2007. Plant–animal mutualistic networks: the architecture of biodiversity. – *Annu. Rev. Ecol. Evol. Syst.* 38: 567–593.
- Bascompte, J. and Stouffer, D. B. 2009. The assembly and disassembly of ecological networks. – *Phil. Trans. R. Soc. B* 364: 1781–1787.
- Bascompte, J. et al. 2006. Asymmetric coevolutionary networks facilitate biodiversity maintenance. – *Science* 312: 431–433.
- Bastolla, U. et al. 2009. The architecture of mutualistic networks minimizes competition and increases biodiversity. – *Nature* 458: 1018–1020.
- Beckett, S. J. 2016. Improved community detection in weighted bipartite networks. – *R. Soc. Open Sci.* 3(1), p. 140536.
- Blader, N. 2018. *rdist: Calculate pairwise distances*. – R package ver. 0.0.3.
- Blonder, B. et al. 2014. The n-dimensional hypervolume. – *Global Ecol. Biogeogr.* 23: 595–609.
- Blüthgen, N. et al. 2006. Measuring specialization in species interaction networks. – *BMC Ecol.* 6: 9.
- Borrelli, J. J. 2015. Selection against instability: Stable subgraphs are most frequent in empirical food webs. – *Oikos* 124: 1583–1588.
- Bramon Mora, B. et al. 2018. *pymfinder: a tool for the motif analysis of binary and quantitative complex networks*. – bioRxiv 364703, doi: <https://doi.org/10.1101/364703>.
- Camacho, J. et al. 2007. Quantitative analysis of the local structure of food webs. – *J. Theor. Biol.* 246: 260–268.
- Campbell, D. R. 1985. Pollinator sharing and seed set of *Stellaria pubera*: competition for pollination. – *Ecology* 66: 544–553.
- Carvalho, L. G. et al. 2014. The potential for indirect effects between co-flowering plants via shared pollinators depends on resource abundance, accessibility and relatedness. – *Ecol. Lett.* 17: 1389–1399.
- Chacoff, N. P. et al. 2012. Evaluating sampling completeness in a desert plant–pollinator network. – *J. Anim. Ecol.* 81: 190–200.
- Chittka, L. and Schürkens, S. 2001. Successful invasion of a floral market: an exotic Asian plant has moved in on Europe's river-banks by bribing pollinators. – *Nature* 411: 653.
- Cirtwill, A. R. and Stouffer, D. B. 2015. Concomitant predation on parasites is highly variable but constrains the ways in which parasites contribute to food web structure. – *J. Anim. Ecol.* 84: 734–744.
- Cirtwill, A. R. et al. 2018. Between-year changes in community composition shape species' roles in an Arctic plant–pollinator network. – *Oikos* 127: 1163–1176.
- Coux, C. et al. 2016. Linking species functional roles to their network roles. – *Ecol. Lett.* 19: 762–770.
- Dáttilo, W. et al. 2013. Spatial structure of ant–plant mutualistic networks. – *Oikos* 122: 1643–1648.
- de Aguiar, M. A. M. et al. 2017. Revealing biases in the sampling of ecological interaction networks. – arXiv: 1708.01242.
- Devoto, M. et al. 2012. Understanding and planning ecological restoration of plant–pollinator networks. – *Ecol. Lett.* 15: 319–328.
- Dorado, J. et al. 2011. Rareness and specialization in plant–pollinator networks. – *Ecology* 92: 19–25.
- Dormann, C. F. et al. 2009. Indices, graphs and null models: analyzing bipartite ecological networks. – *Open Ecol. J.* 2: 7–24.
- Doucier, G. and Stouffer, D. 2015. *Rnetcarto: fast network modularity and roles computation by simulated annealing*. – R package ver. 0.2.4.
- Dupont, Y. L. et al. 2014. Spatial structure of an individual-based plant–pollinator network. – *Oikos* 123: 1301–1310.
- Eklöf, A. et al. 2013. The dimensionality of ecological networks. – *Ecol. Lett.* 16: 577–583.
- Emer, C. et al. 2016. Species roles in plant–pollinator communities are conserved across native and alien ranges. – *Divers. Distrib.* 22: 841–852.
- Faith, D. P. et al. 1987. Compositional dissimilarity as a robust measure of ecological distance. – *Vegetatio* 69: 57–68.
- Flanagan, R. J. et al. 2010. Increased relative abundance of an invasive competitor for pollination, *Lythrum salicaria*, reduces seed number in *Mimulus ringens*. – *Oecologia* 164: 445–454.
- Fontaine, C. et al. 2011. The ecological and evolutionary implications of merging different types of networks. – *Ecol. Lett.* 14: 1170–1181.
- Fort, H. et al. 2016. Abundance and generalisation in mutualistic networks: solving the chicken-and-egg dilemma. – *Ecol. Lett.* 19: 4–11.
- Fox, J. W. 2006. Current food web models cannot explain the overall topological structure of observed food webs. – *Oikos* 115: 97–109.
- Frank van Veen, F. J. et al. 2006. Apparent competition, quantitative food webs, and the structure of phytophagous insect communities. – *Annu. Rev. Entomol.* 51: 187–208.
- Fründ, J. et al. 2016. Sampling bias is a challenge for quantifying specialization and network structure: lessons from a quantitative niche model. – *Oikos* 125: 502–513.
- Ghazoul, J. 2006. Floral diversity and the facilitation of pollination. – *J. Ecol.* 94: 295–304.
- Guimarães, P. R. et al. 2017. Indirect effects drive coevolution in mutualistic networks. – *Nature* 550: 511–514.

- Hay, M. E. 1986. Associational plant defenses and the maintenance of species diversity: turning competitors into accomplices. – *Am. Nat.* 128: 617–641.
- Hochkirch, A. et al. 2012. Conspecific flowers of *sinapis arvensis* are stronger competitors for pollinators than those of the invasive weed *bunias orientalis*. – *Naturwissenschaften* 99: 217–224.
- Jordán, F. et al. 2007. Quantifying positional importance in food webs: a comparison of centrality indices. – *Ecol. Model.* 205: 270–275.
- Jordano, P. 2016. Sampling networks of ecological interactions. – *Funct. Ecol.* 30: 1883–1893.
- Kaiser-Bunbury, C. N. et al. 2010. The robustness of pollination networks to the loss of species and interactions: a quantitative approach incorporating pollinator behaviour. – *Ecol. Lett.* 13: 442–452.
- Kaiser-Bunbury, C. N. et al. 2017. Ecosystem restoration strengthens pollination network resilience and function. – *Nature* 542: 223–227.
- Kashtan, N. et al. 2004. Topological generalizations of network motifs. – *Phys. Rev. E* 70: 12.
- Kondoh, M. 2008. Building trophic modules into a persistent food web. – *Proc. Natl Acad. Sci. USA* 105: 16631–16635.
- Liao, K. et al. 2011. The presence of co-flowering species facilitates reproductive success of *Pedicularis monbeigiana* (Orobanchaceae) through variation in bumble-bee foraging behaviour. – *Ann. Bot.* 108: 877–884.
- Martínez, D. et al. 2014. Consistency and reciprocity of indirect interactions between tree species mediated by frugivorous birds. – *Oikos* 123: 414–422.
- Menke, S. et al. 2012. Plant–frugivore networks are less specialized and more robust at forest–farmland edges than in the interior of a tropical forest. – *Oikos* 121: 1553–1566.
- Milo, R. et al. 2002. Network motifs: simple building blocks of complex networks. – *Science* 298: 824–827.
- Mitchell, R. J. et al. 2009. New frontiers in competition for pollination. – *Ann. Bot.* 103: 1403–1413.
- Moeller, D. A. 2004. Facilitative interactions among plants via shared pollinators. – *Ecology* 85: 3289–3301.
- Morales, C. L. and Traveset, A. 2009. A meta-analysis of impacts of alien vs. native plants on pollinator visitation and reproductive success of co-flowering native plants. – *Ecol. Lett.* 12: 716–728.
- Morris, R. J. et al. 2004. Experimental evidence for apparent competition in a tropical forest food web. – *Nature* 428: 310–313.
- Morris, R. J. et al. 2014. Antagonistic interaction networks are structured independently of latitude and host guild. – *Ecol. Lett.* 17: 340–349.
- Oksanen, J. et al. 2016. *vegan*: community ecology package. – R package ver. 2.4-0.
- Olesen, J. M. et al. 2008. Temporal dynamics in a pollination network. – *Ecology* 89: 1573–1582.
- Olito, C. and Fox, J. W. 2015. Species traits and abundances predict metrics of plant–pollinator network structure, but not pairwise interactions. – *Oikos* 124: 428–436.
- Petanidou, T. et al. 2008. Long-term observation of a pollination network: fluctuation in species and interactions, relative invariance of network structure and implications for estimates of specialization. – *Ecol. Lett.* 11: 564–575.
- Pfister, C. A. and Hay, M. E. 1988. Associational plant refuges: convergent patterns in marine and terrestrial communities result from differing mechanisms. – *Oecologia* 77: 118–129.
- Poisot, T. et al. 2012. A comparative study of ecological specialization estimators. – *Methods Ecol. Evol.* 3: 537–544.
- Poisot, T. et al. 2013. Trophic complementarity drives the biodiversity–ecosystem functioning relationship in food webs. – *Ecol. Lett.* 16: 853–861.
- Rathcke, B. 1983. Competition and facilitation among plants for pollination. – In: Real, L. (ed.), *Pollination biology*. Academic Press, pp. 305–329.
- Rivera-Hutinel, A. et al. 2012. Effects of sampling completeness on the structure of plant–pollinator networks. – *Ecology* 93: 1593–1603.
- Rodríguez-Rodríguez, M. C. et al. 2017. Functional consequences of plant–animal interactions along the mutualism–antagonism gradient. – *Ecology* 98: 1266–1276.
- Runquist, R. B. and Stanton, M. L. 2013. Asymmetric and frequency-dependent pollinator-mediated interactions may influence competitive displacement in two vernal pool plants. – *Ecol. Lett.* 16: 183–190.
- Saavedra, S. et al. 2009. A simple model of bipartite cooperation for ecological and organizational networks. – *Nature* 457: 463–466.
- Saracco, F. et al. 2017. Inferring monopartite projections of bipartite networks: an entropy-based approach. – *N. J. Phys.* 19: 053022.
- Sayago, R. et al. 2013. Evaluating factors that predict the structure of a commensalistic epiphyte–phorophyte network. – *Proc. R. Soc. B* 280: 20122821.
- Sieber, Y. et al. 2011. Do alpine plants facilitate each other's pollination? Experiments at a small spatial scale. – *Acta Oecol.* 37: 369–374.
- Simmons, B. I. et al. 2018. *bmotif*: a package for counting motifs in bipartite networks. – bioRxiv 302356; doi: <https://doi.org/10.1101/302356>.
- Sotomayor, D. A. and Lortie, C. J. 2015. Indirect interactions in terrestrial plant communities: emerging patterns and research gaps. – *Ecosphere* 6: 103.
- Staniczenko, P. P. A. et al. 2017. Linking macroecology and community ecology: refining predictions of species distributions using biotic interaction networks. – *Ecol. Lett.* 20: 693–707.
- Stouffer, D. B. and Bascompte, J. 2010. Understanding food-web persistence from local to global scales. – *Ecol. Lett.* 13: 154–161.
- Stouffer, D. B. and Bascompte, J. 2011. Compartmentalization increases food-web persistence. – *Proc. Natl Acad. Sci. USA* 108: 3648–3652.
- Stouffer, D. B. et al. 2012. Evolutionary conservation of species' roles in food webs. – *Science* 335: 1489–1492.
- Stouffer, D. B. et al. 2014. How exotic plants integrate into pollination networks. – *J. Ecol.* 102: 1442–1450.
- Strauss, S. Y. 1991. Indirect effects in community ecology – their definition, study and importance. – *Trends Ecol. Evol.* 6: 206–210.
- Tack, A. J. M. et al. 2011. Can we predict indirect interactions from quantitative food webs? An experimental approach. – *J. Anim. Ecol.* 80: 108–118.
- Temeles, E. J. et al. 2016. Pollinator competition as a driver of floral divergence: an experimental test. – *PLoS One* 11(1): e0146431.
- Thompson, R. M. et al. 2012. Food webs: reconciling the structure and function of biodiversity. – *Trends Ecol. Evol.* 27: 689–697.
- Traveset, A. et al. 2015. Bird–flower visitation networks in the Galápagos unveil a widespread interaction release. – *Nat. Commun.* 6: 6376.

- Vamosi, J. C. et al. 2014. Pollinators visit related plant species across 29 plant–pollinator networks. – *Ecol. Evol.* 4: 2303–2315.
- Vandermeer, J. et al. 1985. Indirect facilitation and mutualism. – In: Boucher, D. H. (ed.), *The biology of mutualism: ecology and evolution*. Oxford Univ. Press, pp. 326–343.
- Vázquez, D. P. et al. 2009. Evaluating multiple determinants of the structure of plant–animal mutualistic networks. – *Ecology* 90: 2039–2046.
- Vázquez, D. P. et al. 2015. A conceptual framework for studying the strength of plant–animal mutualistic interactions. – *Ecol. Lett.* 18: 385–400.
- Verdú, M. and Valiente-Banuet, A. 2011. The relative contribution of abundance and phylogeny to the structure of plant facilitation networks. – *Oikos* 120: 1351–1356.
- Vilà, M. et al. 2009. Invasive plant integration into native plant–pollinator networks across Europe. – *Proc. R. Soc. B* 276: 3887–3893.
- Vizentin-Bugoni, J. et al. 2014. Processes entangling interactions in communities: forbidden links are more important than abundance in a hummingbird–plant network. – *Proc. R. Soc. B* 281: 20132397.
- Waser, N. M. 1983. Competition for pollination and floral character differences among sympatric plant species: a review of the evidence. – In: Jones, C. E. and Little, P. J. (eds), *Handbook of experimental pollination biology*. Scientific and Academic Editions, pp. 277–293.
- Wootton, J. T. 1994. The nature and consequences of indirect effects in ecological communities. – *Annu. Rev. Ecol. Syst.* 25: 443–466.
- Wootton, J. T. 2002. Indirect effects in complex ecosystems: recent progress and future challenges. – *J. Sea Res.* 48: 157–172.
- Ye, Z. M. et al. 2014. Competition and facilitation among plants for pollination: can pollinator abundance shift the plant–plant interactions? – *Plant Ecol.* 215: 3–13.
- Zhao, L. et al. 2018. Identifying compartments in ecological networks based on energy channels. – *Ecol. Evol.* 8: 309–318.
- Zhou, T. et al. 2007. Bipartite network projection and personal recommendation. – *Phys. Rev. E* 76: 046115.

Supplementary material (available online as Appendix oik-05670 at <www.oikosjournal.org/appendix/oik-05670>). Appendix 1–3.